

ICE AIR[®]
World Class Comfort[®]

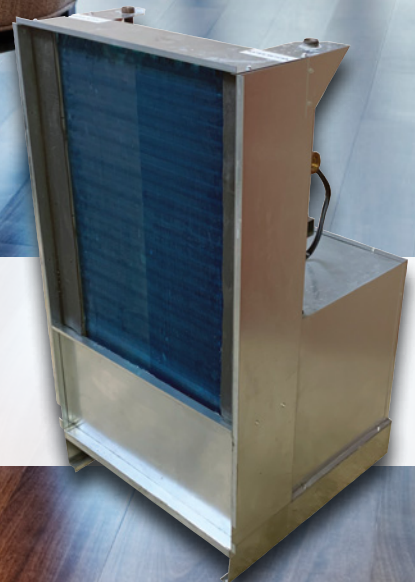

*Introducing
Series 816 Chassis Replacement*



WSHP

Ice Air Series 816

Replaces ClimateMaster 816

When it's time to replace your Vertical WSHP chassis...you want to install the best parts.

The Ice Air Series 816 Chassis Replacement is designed to exactly replace the ClimateMaster 816 Vertical Stacked Water Source Heat Pump (WSHP). Series 816 provides environmentally friendly cooling and heating where individual, quiet control is a priority.

Featuring Ice Air ExactFit™, the Series 816 is dimensionally identical to the original for a fast, easy, and trouble-free installation. Quality components, careful design and testing and the latest in environmentally friendly technology advances mean long unit life, user satisfaction and lower energy costs. No field modification kits or builder renovations required.

Ice Air is the replacement solution the competition can't match.

The application-flexible Series 816 chassis is a part of a complete system, which consists of the chassis, blower section, control box, and furred-in room cabinet with risers. The chassis contains the compressor, air side heat exchanger, water side heat exchanger, and refrigerant circuit control and safety components.

Fast and Easy Replacement

The Ice Air Series 816 replacement chassis fits the existing ClimateMaster room cabinets and works with the existing blower section and control box without modification. Because the chassis dimensions and construction details are like the original, replacement is fast and easy. The chassis is designed to fit into the existing wall sleeve, ensuring a simple slide-in retrofit to the existing unit. Using Ice Air Series 816 chassis replacement eliminates the need for room renovation, redecorating, and piping changes and is the solution that gets you back in service quickly and at the lowest total cost.

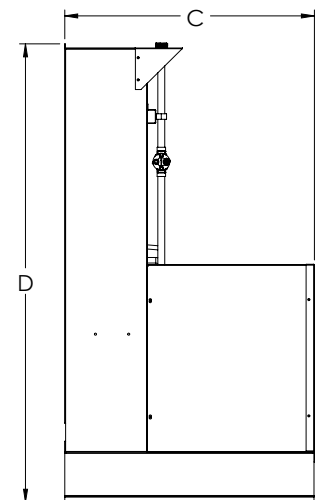
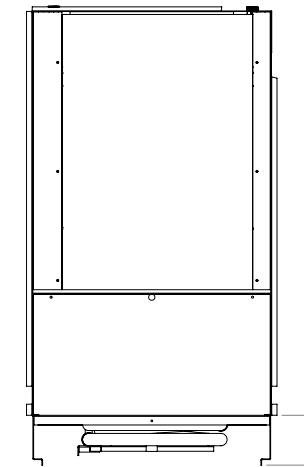
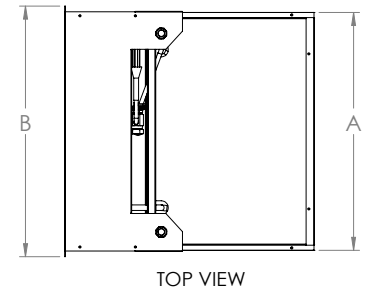
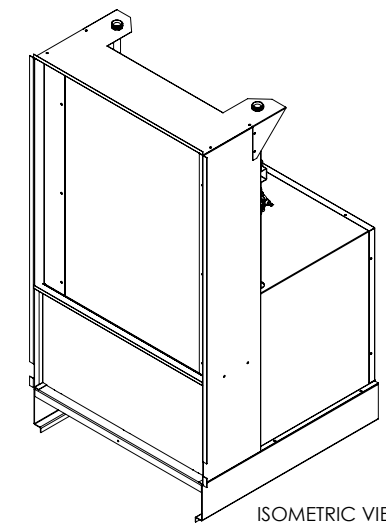

MODEL SIZE	A	B	C	D	E
09, 12, 15	14 1/2	15 1/2	15 1/2	36 3/4	4 1/4
18	17 3/8	18 1/2	18 5/8	41 3/8	4 1/2
24, 30, 36	21 1/2	22 5/8	22 1/2	41 3/8	4 1/2

We have 40 years of experience in providing superior cooling and heating products, guaranteeing a highly efficient, top quality replacement unit that will provide many years of quiet, reliable comfort conditioning.

SERIES MODEL #	8VS81609	8VS81612	8VS81615	8VS81618	8VS81624	8VS81630	8VS81624
Cooling Capacity (Btu/hr)	9,000	12,500	13,300	18,000	25,200	27,000	36,000
Sensible Capacity (Btu/hr)	7,100	9,700	10,600	12,800	20,200	22,200	26,220
Cooling EER	13.3	14.4	14.4	14.1	13.7	13.7	13.0
Heating Capacity (Btu/hr)	12,000	14,000	15,300	20,100	31,000	32,000	41,000
Heating COP	4.4	4.5	4.4	4.4	4.4	4.4	4.3
Flow Rate (GPM)	2.5	3.0	3.8	5.0	7.0	7.5	9.0
Typical CFM	420	440	460	630	1000	1000	1150

SPECIFICATION NOTES:
 COOLING CAPACITY BTUH RATED @ 80.6°F DB, 66.2°F WB EAT, 86°F EWT @ 3 GPM/TON
 HEATING CAPACITY BTUH RATED @ 68°F DB, 59°F WB EAT, 68°F EWT @ 3 GPM/TON

Electrified Product Family



* By making energy-saving upgrades today, you can give your building a head start on upcoming changes to city regulations such as NYC Law 97.

RSXC Series*

Cold Climate PTHPs give you the performance of a VRF system with the convenience of a PTAC. Using breakthrough cold climate technology allows Ice Air PTHPs to efficiently provide space heating down to -5°F and below.



RSXC-S Series*

Ice Air's RSXC-S Series Cold Climate heat pumps offer a slim, sleek design and efficiently provide space heating to -5°F and below.



RSXC-DH Series*

RSXC-DH air source heat pumps are compact, with advanced, two-stage dual heating capabilities (partial cold climate operation down to 23°F then supplemental electric heat resistance for increased output).

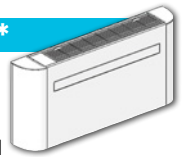

SPXC Series*

Cold Climate SPHPs are self-contained, concealed, ducted systems. This line of vertical packaged heat pumps serves multiple spaces through concealed ductwork to efficiently provide space heating to -5°F and below.



HPWH Series*

Air-Source Cold Climate Heat Pump Water Heaters capture the free energy in the environment and convert it to hot water. These units are certified to operate down to -13°F.



HPWH-SC Series*

Air-Source Cold Climate heat pump chiller heaters capture free energy in the environment to provide both hot and chilled water. These units are certified to operate down to -13°F.



VSHPGE Geothermal*

Ice Air's Geothermal WSHP is a versatile geothermal heat pump that is available in a range of sizes and configurations for convenient installation. Fully compatible with geothermal conditions, it provides an ideal solution for whisper quiet cooling and heating within a tight footprint.



ICE AIR VRF

New technologies like Variable Refrigerant Flow (VRF) are on the move. There is no denying the benefits of VRF any longer, and with Ice Air VRF, these benefits are delivered simply and effectively.



Other Products

FCU

Fan Coil Units



This simple and easy cooling and heating solution provides reliable performance, high efficiency, ease of operation, low cost, easy installation, quiet comfort and a variety of solution-based options.

HWAC

Hybrid Water-Cooled Air Conditioners



HWACs provide hydronic heat without using the unit's compressor through an innovative system that combines high-efficiency cooling with a hot water coil.

WSHP

Water Source Heat Pumps

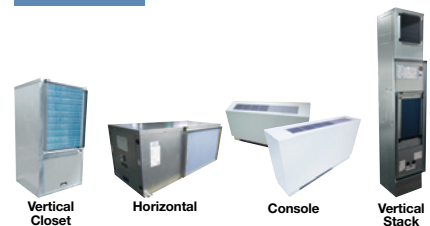

WSHPs provide efficient room-by-room comfort. Units function independently and are piped to a central water loop.

PTAC

Packaged Terminal Air Conditioners

PTACs are designed for ultra-high efficiency and comply with LEED® criteria in a durable, user-friendly package. Available for new construction, retrofit and ExactFit™ replacement applications.



NEW! Ice Air CEU Webinar

Learn more about the role HVAC electrification plays in building decarbonization today at www.iceairceu.com.



80 Hartford Avenue,
Mount Vernon, NY 10553
Tel: 877-ICE-AIR-1 (877-423-2471)
Main: 914-668-4700
Fax: 914-668-5643
email: sales@ice-air.com
www.ice-air.com